

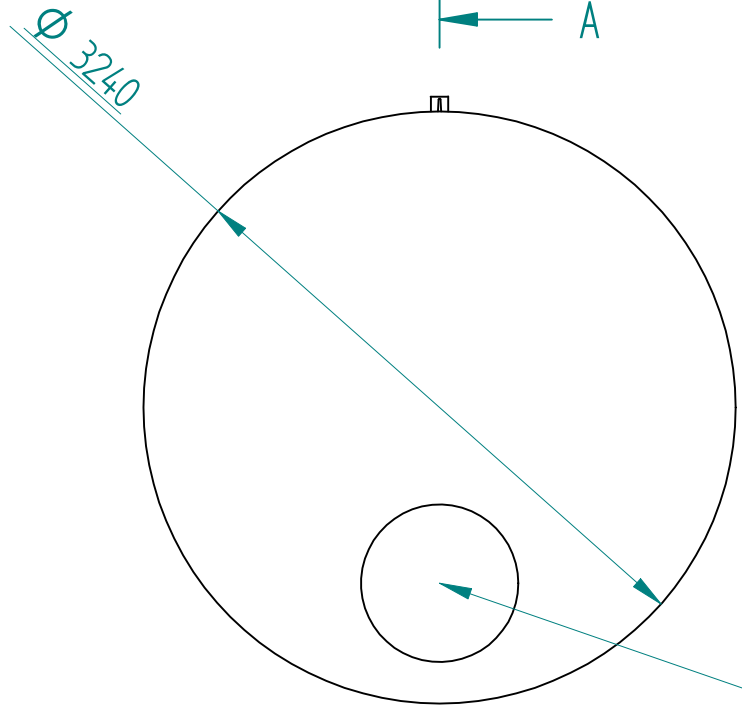

COUPE A-A

Option : vidange

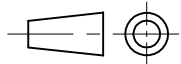

Ø 600 mm

Matière : PE HD	Date : 19/12/2011	Dessiné par : DR
Feuille : 1 / 1	Titre : CAE 15 000 L	
	SOROCAL	
Solid Edge EDS PLM Solutions	Poids = 420 kg	
		

SOLID EDGE ACADEMIC COPY