

COUPE A-A

Option : vidange

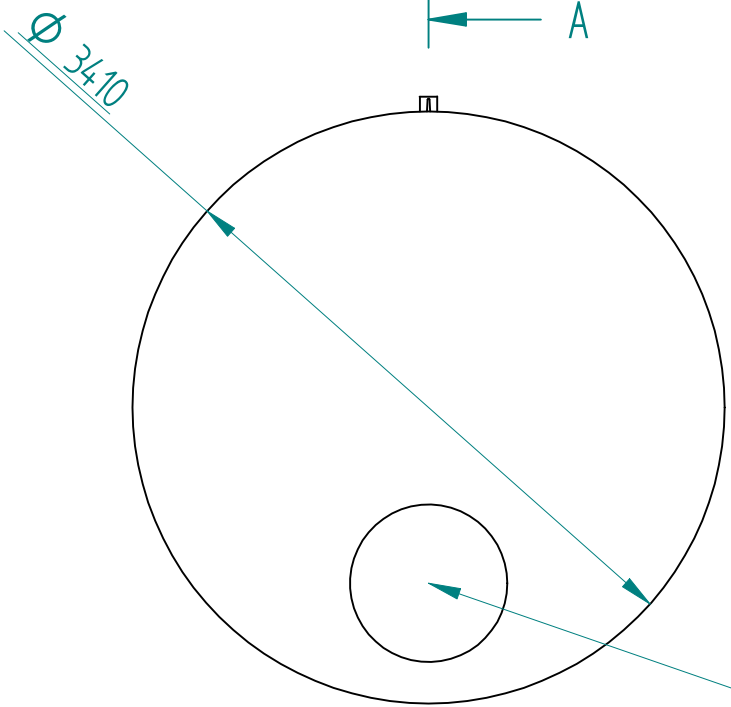

Matière : PE HD	Date : 15/11/2010	Dessiné par : DR
Feuille : 1 / 1	Titre : <b>CAE 17 000 L</b>	
	<b>SOROCAL</b>	
<b>Solid Edge</b> EDS PLM Solutions	Poids = 464 kg	

SOLID EDGE ACADEMIC COPY