

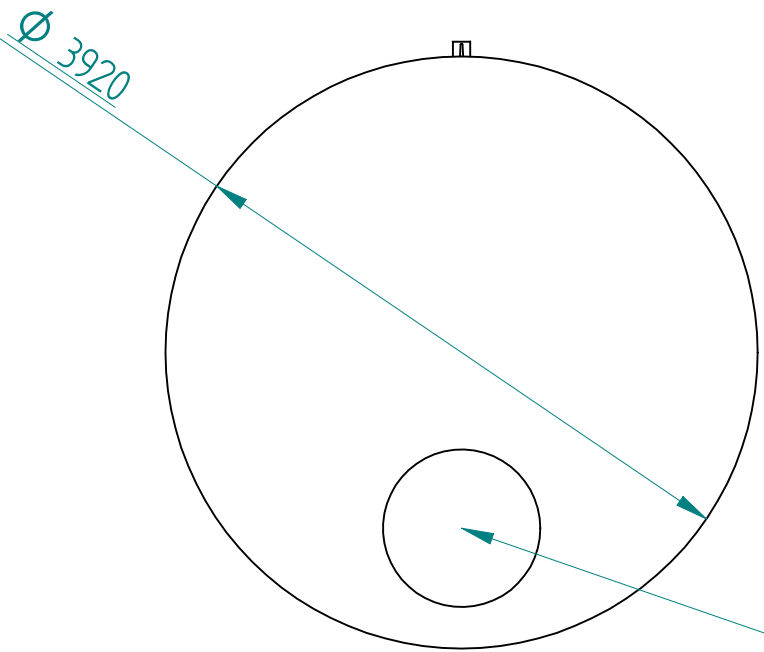

COUPE A-A

Option : vidange

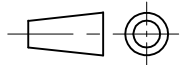

Matière : PE HD	Date : 06/01/2012	Dessiné par : DR
Feuille : 1 / 1	Titre : CAE 25 000 L	
	SOROCAL	
Solid Edge EDS PLM Solutions	Poids = 572 Kg	

SOLID EDGE ACADEMIC COPY