

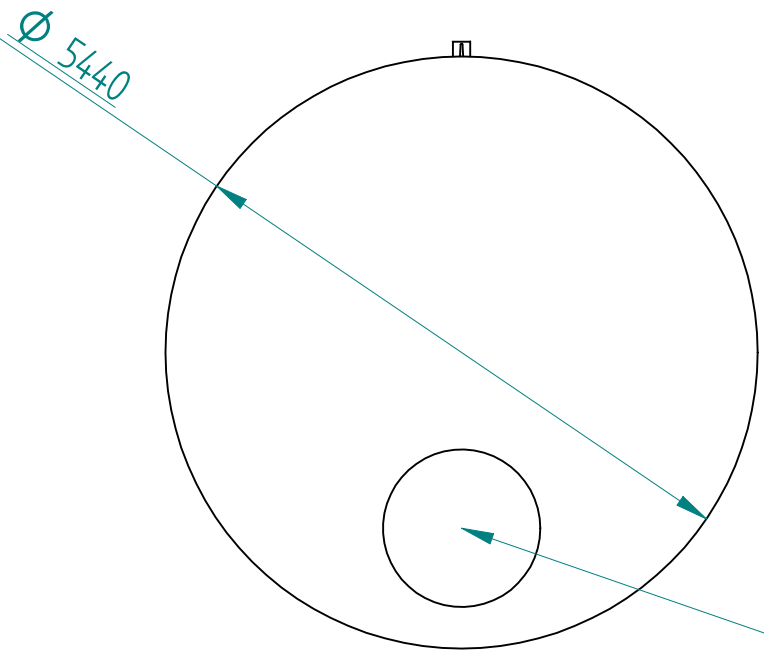

COUPE A-A

Option : vidange

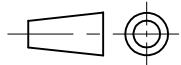

Matière : PE HD	Date : 30/04/2014	Dessiné par : DR
Feuille : 1 / 1	Titre : CAE 50 000 L	
	SOROCAL	
Solid Edge EDS PLM Solutions	Poids = 1285 Kg	

SOLID EDGE ACADEMIC COPY