

COUPE A-A

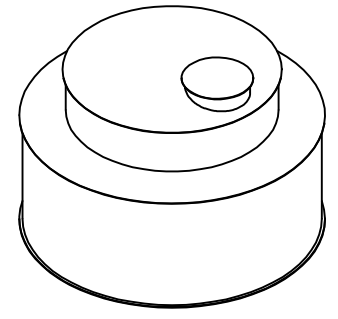
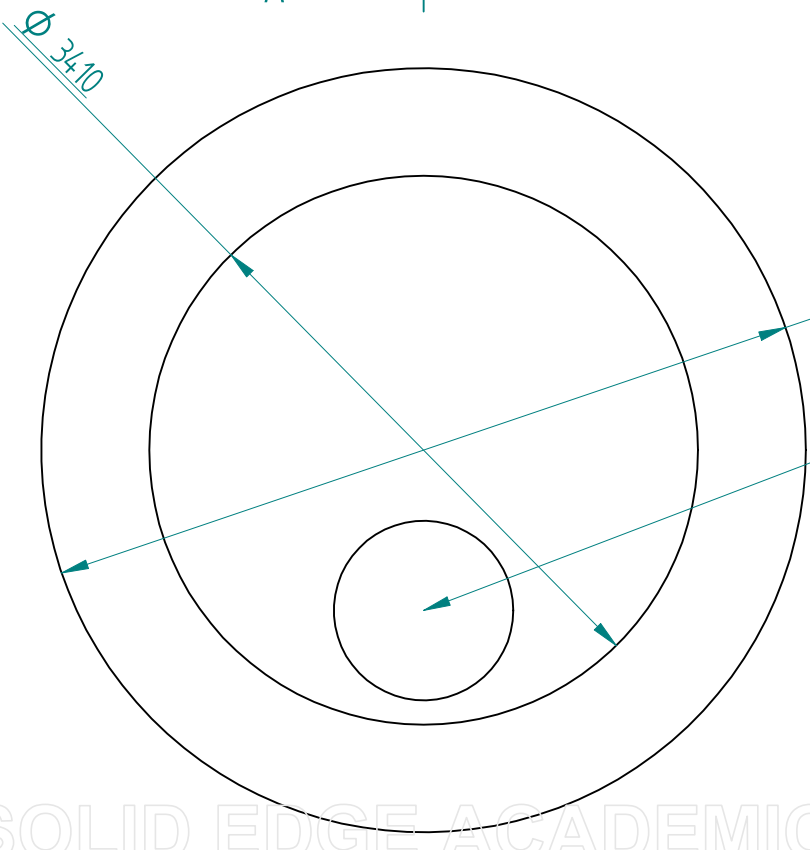

Matière : HDPE	Date : 24/06/2013	Dessiné par : DR
Feuille : 1 / 1	Titre : Cuve stockage huile double peau	
	17 000 L	
Solid Edge EDS PLM Solutions	Poids = 993 Kg	

SOLID EDGE ACADEMIC COPY