

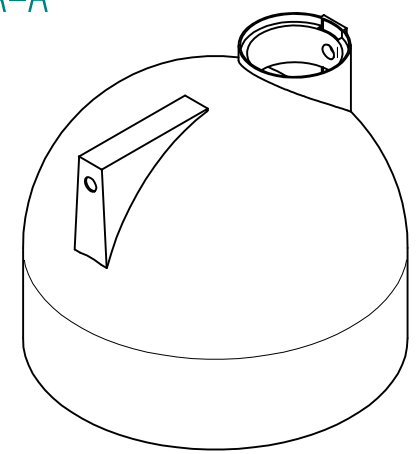

COUPE A-A

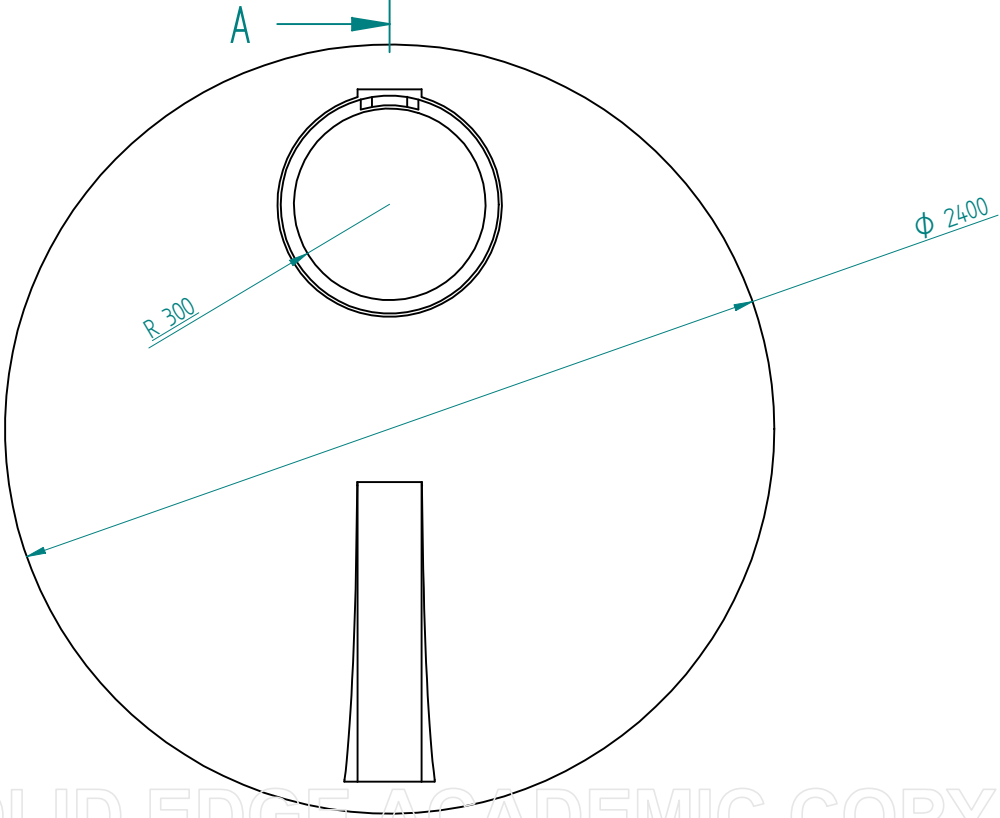
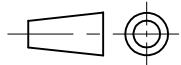

Matière : LLDPE	Date : 24/08/2015	Dessiné par : DR
Feuille : 1 / 1	Titre : Débourbeur 8000 L	
	SOROCAL	
Solid Edge EDS PLM Solutions	Poids = 250 Kg	
		

SOLID EDGE ACADEMIC COPY