

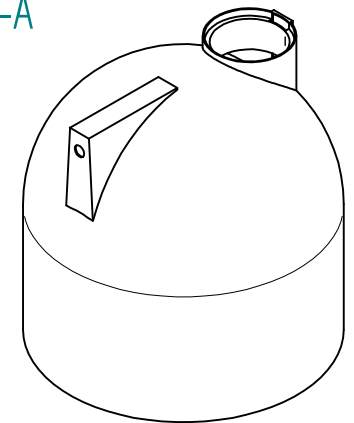

COUPE A-A

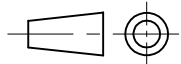

Matière : LLDPE	Date : 24/08/2015	Dessiné par : DR
Feuille : 1 / 1	Titre : Percolateur 10000 L	
	SOROCAL	
Solid Edge EDS PLM Solutions	Poids = 290 Kg	
		

SOLID EDGE ACADEMIC COPY