

H G F E D C B A

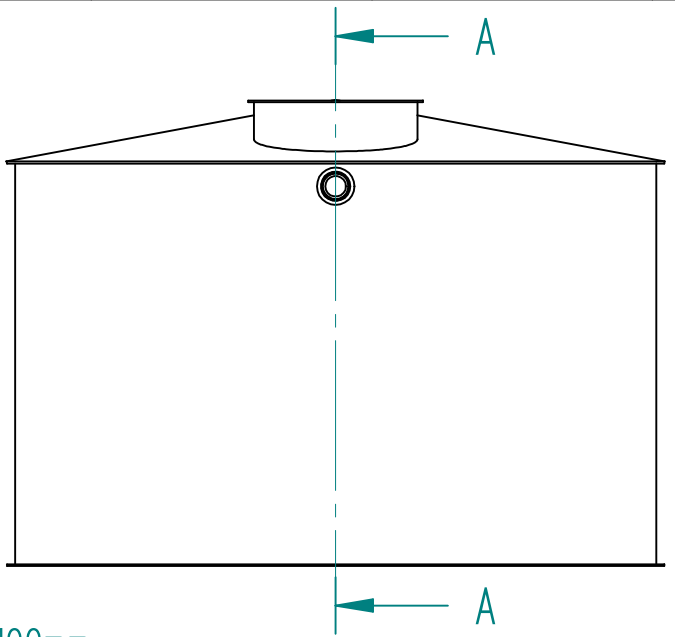

Ø 100mm

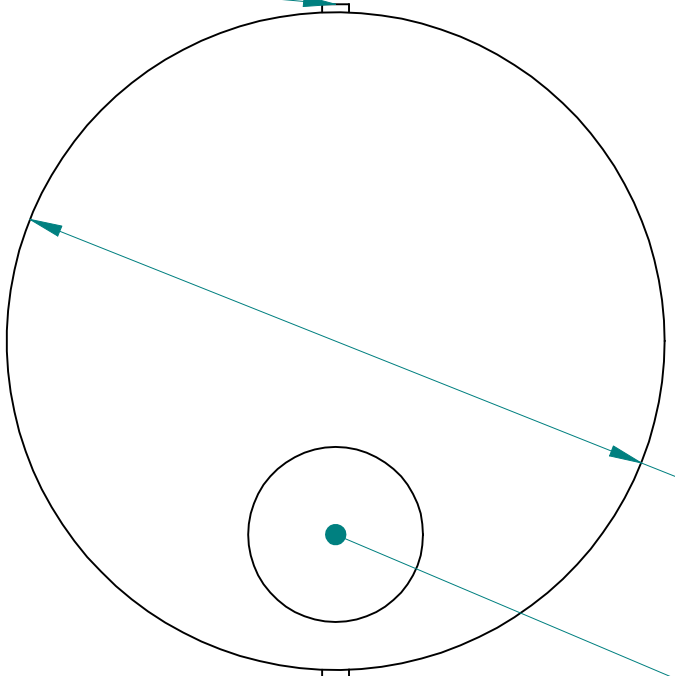

Ø 2060

Ø 600mm

Ø 100mm

1700

1500

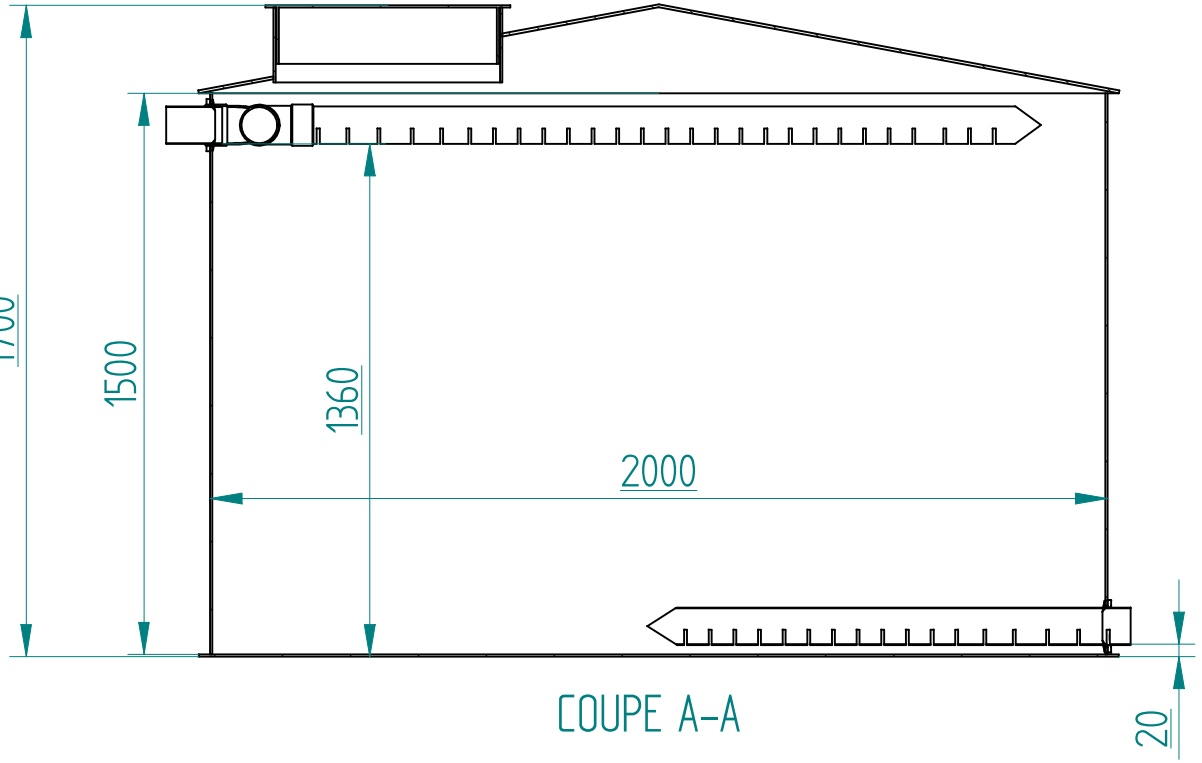

1360

2000

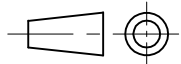

COUPE A-A

20

Matière : PE HD	Date : 15/11/2010	Dessiné par : DR
Feuille : 1 / 1	Titre : Percolateur 4000 L	
	SOROCAL	
Solid Edge EDS PLM Solutions	Poids = 108 kg	
		

SOLID EDGE ACADEMIC COPY

H G F E D C B A